

PRICE LIST

09 - 2017





THE VETERINARY SPECIALIST COMPANY





Important notice

This catalog and price list are indicative. The characteristics of the articles, the composition of the kits and the prices can be changed by Ad Miora without the need for any preliminary notice.







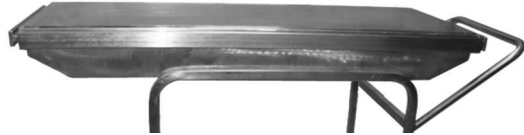
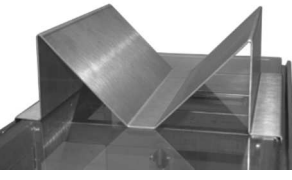
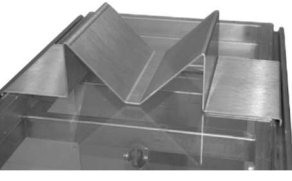
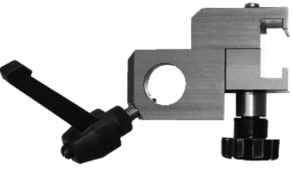

Ergomed 99 series - Surgical tables

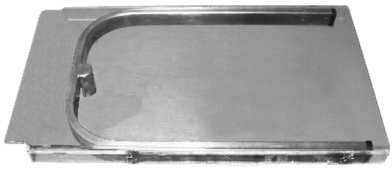





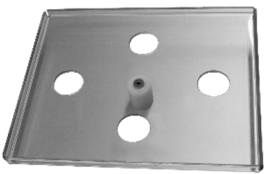

 <p>Picture: table without top</p>	<p>Up/down and trendelenburg movements Single-column structure Low voltage control Rollover protection device Handling wheels</p> <p>Can be equipped with all standard accessories</p> <p>Top to be added at customer's choice</p>	<p>Ergomed 99 - 2M</p>
		<p>T00010013A</p>
		<p>€ 1,950.00</p>
 <p>Picture: table without top</p>	<p>Same features as the previous model plus:</p> <ul style="list-style-type: none"> Lateral tilting Stabilizing suckers Disconnectable cables <p>Can be equipped with all standard accessories</p> <p>Top to be added at customer's choice</p>	<p>Ergomed 99 - 3M-E</p>
		<p>T00010012A</p>
		<p>€ 2,690.00</p>

Ergomed 99 series - Accessories

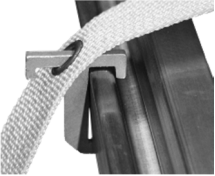

	Stainless steel	Stainless steel top
		P00020001A
		€ 116.80
	Lexan	Lexan® top
		P00020002A
		€ 147.40
	Plastic	Heated top
		P00020008A
		€ 385.20
	Stainless steel	Tilttable top for toraco-laparoscopy
		P00020005A
		€ 320.00
	Stainless steel	Stretcher trolley
		C00010001A
		Only on order Require quotation
	Stainless steel	Stretcher trolley top
		P00020003A
		€ 144.00
	Stainless steel	Big dorsal positioner
		P00030001A
		€ 61.60
	Stainless steel	Small dorsal positioner
		P00030002A
		€ 44.00
	Aluminum alloy	Universal clamp
		M00010015A
		€ 115.80

Ergomed 99 series - Accessories

	Lexan	Lexan® extension
		E00010003A
		€ 86.10
	Stainless steel	Armrest for microsurgery
		S00010002A
		€ 58.40
	Stainless steel	Side positioners (pairs)
		S00010001A
		€ 77.20
	Stainless steel	Tiltable fluid collection tray
		V00010006A
		€ 72.20
	Stainless steel	Hold-up bar for surgical draping
		A00030004A
		€ 57.40
	Stainless steel	Rod for drip
		A00030005A
		€ 52.40
	Stainless steel	Surgical tray 300x400 mm
		S00010004A
		€ 115.80
	Lexan	X-ray cassette tray
		S00010003A
		€ 59.80
	Stainless steel	Traction bar
		A00030003A
		€ 227.70

Ergomed 99 series - Accessories		
	Stainless steel	Extension 250 mm
		E00010004A
		€ 57.40
	Stainless steel	Extension 500 mm
		E00010005A
		€ 65.30
	Stainless steel	Stabilizing rod
		B00010009A
		€ 83.10
	Fabric	Patient retention band 0.9 m
		F00010001A
	Fabric	Patient retention band 1.8 m
		F00010002A
	Aluminium alloy	Retention band hook
		G00010003A
		€ 11.20
	Polyurethane	Protective polyurethane
		P00040001A
		€ 5.40
	40 kg maximum load	40 kg digital dynamometer
		S00030005A
		€ 24.00
	Stainless steel	Accessory rack
		C00010002A
		€ 245.50

Ergomed 99 series - Accessories

	80 mm maximum width Stainless steel	Traction stirrup 80 mm S00020001A € 112.80
	120 mm maximum width Stainless steel	Traction stirrup 120 mm S00020002A € 119.70
	160 mm maximum width Stainless steel	Traction stirrup 160 mm S00020003A € 131.60
	Fabric	Traction belt with chain C00030002A € 20.20
Versions on request (to be specified at the order)		
	It allows the transport of the surgical table top by the trolley cod. C00010001A Stainless steel	Stretcher frame P00020004A Only on order Require quotation





Universal system - Mini linear radiolucent kit

	Suggested use: cats and toy dogs	Mini linear radiolucent kit
		K00010001B
		€ 334,40





COMPOSITION OF THE KIT





CODE	QTY	CODE	QTY	CODE	QTY	CODE	QTY
C00040008A	1	M00010020A	8	M00010021A	4	G00010001A	10
G00010002A	6	G00010004A	6	D00010019A	20	R00020006A	20
B00010010A	2	B00010011A	2	B00010001A	2	B00010012A	2
B00010002A	2	V00020013A	10	F00020170A	2	F00020171A	2
F00020172A	2	F00020173A	2	F00020156A	2	P00040004A	8
P00040005A	4						

Mini linear radiolucent kit - Spare parts

	Thermoplastic material	Autoclavable box for mini linear radiolucent fixator kit
		C00040008A
		€ 22.00
	Technopolymer	Radiolucent round clamp Ø 20 mm, three 3 mm holes - linear layout, black
		M00010020A
		€ 10.00
	Technopolymer	Radiolucent round clamp Ø 20 mm, three 3 mm holes - triangular layout, black
		M00010021A
		€ 10.00
	Stainless steel M3 thread	Hook Ø 3 mm L 16.5 mm x 5.0 mm
		G00010001A
		€ 3.00
	Stainless steel M3 thread	Hook Ø 3 mm L 24.5 mm x 5.0 mm
		G00010002A
		€ 3.00
Stainless steel M3 thread	Hook Ø 3 mm L 16.5 mm x 7.5 mm	
	G00010004A	
	€ 3.00	

Mini linear radiolucent kit - Spare parts

	Stainless steel	Self-locking M3 nut
		D00010019A
		€ 0.30
	Stainless steel	Toothed washer 3 mm hole
		R00020006A
		€ 0.10
	Carbon composite	Carbon bar Ø 5.0 mm, L 50 mm
		B00010010A
		€ 2.50
	Carbon composite	Carbon bar Ø 5.0 mm, L 75 mm
		B00010011A
		€ 2.75
	Carbon composite	Carbon bar Ø 5.0 mm, L 100 mm
		B00010001A
		€ 3.00
	Carbon composite	Carbon bar Ø 5.0 mm, L 125 mm
		B00010012A
		€ 3.50
Carbon composite	Carbon bar Ø 5.0 mm, L 150 mm	
	B00010002A	
	€ 4.00	
	Trocar tip	K wire Ø 1.2 mm L 120, 10 mm positive thread
		F00020170A
		€ 7.20
	Trocar tip	K wire Ø 1.5 mm L 120, positive thread
		F00020171A
		€ 7.20

Mini linear radiolucent kit - Spare parts		
	Trocar tip	K wire Ø 1.6 mm L 150, 10 mm negative thread
		F00020172A
		€ 5.90
	Self-tapping 15 mm thread	Threaded pin Ø 2.0 mm L 100 mm
		F00020173A
		€ 10.50
	Self-tapping 15 mm thread	Threaded pin Ø 2.4 mm L 100 mm
		F00020156A
		€ 10.50
	Stainless steel	Screw, M3x20 mm
		V00020013A
		€ 0.25
	Rubber	Cap for pins up to Ø 2.0 mm
		P00040004A
		€ 0.15
	Rubber	Cap for pins Ø 2.4-2.7 mm
		P00040005A
		€ 0.15

Universal system - Dynamizable kit

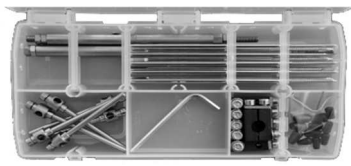

Suggested use: dogs 10 kg
in weight and above

Dynamizable kit

K00010002A

€ 558,70

COMPOSITION OF THE KIT

CODE	QTY	CODE	QTY	CODE	QTY	CODE	QTY
C00040010A	1	F00030001A	1	F00030002A	1	M00010018A	6
F00020176A	4	F00020169A	4	E00010001A	2	P00040002A	4
P00040005A	4	U00010002A	1				

Dynamizable kit - Spare parts



Thermoplastic material

Autoclavable box for dynamizable kit

C00040010A

€ 22.00



Stainless steel

Linear, dynamizable fixator, 10 cm
long

F00030001B

€ 128.00

Stainless steel

Linear, dynamizable fixator, 15 cm
long

F00030002B

€ 137.00



Aluminum alloy

Clamp for dynamizable fixator

M00010018A

€ 27.00



Self-tapping
20 mm thread

Threaded pin, Ø 2.8 mm L 120 mm

F00020169A

€ 10.50





Self-tapping
25 mm thread

Threaded pin, Ø 3.5 mm L 130 mm

F00020176A

€ 10.50

Dynamizable kit - Spare parts

	Stainless steel	Extension for clamp
		E00010001A
		€ 11.00
	Rubber	Cap for pins Ø 2.0-2.7 mm
		P00040005A
		€ 0.15
	Rubber	Cap for pins Ø 3.5 mm
		P00040002A
		€ 0.15
	Stainless steel	Hexagonal wrench, with spherical tip
		U00010002A
		€ 2.50





Universal system - Mini hybrid fixator kit







	Suggested use: cats and toy dogs	Mini hybrid fixator kit
		K00010003A
		€ 1022,05

COMPOSITION OF THE KIT

CODE	QTY	CODE	QTY	CODE	QTY	CODE	QTY
C00040018A	1	A00020005B	2	A00020009B	3	M00010003A	3
B00040002A	1	B00040004A	1	M00010020A	4	M00010021A	4
C00020001A	1	C00020002A	1	C00020003A	1	G00010001A	4
G00010002A	4	G00010004A	4	V00030002A	12	D00010003A	20
D00010008A	1	D00010018A	3	D00010019A	20	D00020003A	12
D00020004A	2	R00030002A	12	R00030001A	2	R00030004A	12
R00030008A	24	R00030009A	6	R00020002A	3	R00020003A	20
F00020156A	5	F00020157A	5	F00020172A	2	F00020173A	4
F00020172A	4	P00040004A	2	P00040005A	8	B00020015A	4
B00020016A	4	B00020017A	4	B00020018A	4	B00020019A	4
V00020001A	4	V00020002A	4	V00020003A	4		

Mini hybrid fixator kit - Spare parts





	Thermoplastic material	Autoclavable box for mini hybrid fixator kit
		C00040018A
		€ 30.00
	Carbon composite	Carbon ring 270°, Ø 54 mm, 3 mm thick
		A00020005B
		€ 37.00
	Carbon composite	Carbon ring 360°, Ø 54 mm, 3 mm thick
		A00020009B
		€ 40.00
	Aluminum alloy	Wire/pin holding clamp, M6 thread
		M00010003A
		€ 9.00

Mini hybrid fixator kit - Spare parts		
	Technopolymer	Radiolucent 1-hole rail, orthogonal, M6 thread B00040004A € 34.00
	Technopolymer	Radiolucent 1-hole rail, inclinable, M6 thread B00040002A € 36.00
	Aluminum alloy screw and 2 washer included	1-hole pin-holding cylinder C00020001A € 10.00
	Aluminum alloy screw and 2 washer included	2-hole pin-holding cylinder C00020002A € 14.00
	Aluminum alloy screw and 2 washer included	3-hole pin-holding cylinder C00020003A € 18.00
	Stainless steel M3 thread	Hook Ø 3 mm L 16.5 mm x 5.0 mm G00010001A € 3.00
	Stainless steel M3 thread	Hook Ø 3 mm L 24.5 mm x 5.0 mm G00010002A € 3.00
	Stainless steel M3 thread	Hook Ø 3 mm L 16.5 mm x 7.5 mm G00010004A € 3.00
	Technopolymer	Radiolucent round clamp Ø 20 mm, three 3 mm holes - linear layout, black M00010020A € 10.00





Mini hybrid fixator kit - Spare parts

	Technopolymer	Radiolucent round clamp Ø 20 mm, three 3 mm holes - triangular layout, black
		M00010021A
		€ 10.00
	Stainless steel	Hexagonal head perforated screw M5 x 13.5 mm, for K wires
		V00030002A
		€ 2.50
	Stainless steel	M6 nut for clamp and post
		D00010018A
		€ 0.50
	Stainless steel	M5 flanged nut
		D00010003A
		€ 0.40
	Aluminum alloy	M5 hemispherical nut, grey
		D00020003A
		€ 8.00
	Aluminum alloy	M6 hemispherical nut, gold
		D00020004A
		€ 8.00
	Stainless steel	Hemispherical washer 8 x 14 mm
		R00030002A
		€ 3.00
	Stainless steel	Hemispherical washer 10 x 16 mm
		R00030001A
		€ 3.00
Thermoplastic material	Radiolucent hemispherical washer, 8 x 13 mm	
	R00030004A	
	€ 4.00	

Mini hybrid fixator kit - Spare parts

	Stainless steel	Self-locking M3 nut
		D00010019A
		€ 0.30
	Aluminum alloy	Self-locking golden color M6 nut
		D00010008A
		€ 1.35
	Stainless steel	Self-centering rectangular washer 5.5 x 15 mm
		R00030008A
	Stainless steel	Self-centering rectangular washer 8.5 x 15 mm
		R00030009A
	Stainless steel	Round washer 7.5 x 14 mm
		R00020002A
	Stainless steel	Round washer 5.5 x 15 mm
		R00020003A
	Half tip	K wire half tip, Ø 1.0 mm L 220 mm
		F00020157A
	Half tip	K wire half tip, Ø 1.2 mm L 250 mm
		F00020158A
	Trocar tip	K wire Ø 1,6 mm L 150 mm, negative thread 15 mm
		F00020172A
		€ 5.90

Mini hybrid fixator kit - Spare parts

	Self-tapping 15 mm thread	Threaded pin Ø 2.0 mm L 100 mm
		F00020173A € 10.50
	Self-tapping 15 mm thread	Threaded pin Ø 2.4 mm L 100 mm
		F00020156A € 10.50
	Rubber	Cap for pins up to Ø 2.0 mm
		P00040004A € 0.15
	Rubber	Cap for pins Ø 2.0-2.7 mm
		P00040005A € 0.15
	Aluminum alloy	Lightweight M5 threaded bar L 50 mm
		B00020015A € 4.20
	Aluminum alloy	Lightweight M5 threaded bar L 70 mm
		B00020016A € 4.20
	Aluminum alloy	Lightweight M5 threaded bar L 90 mm
B00020017A € 4.20		
Aluminum alloy	Lightweight M5 threaded bar L 110 mm	
	B00020018A € 4.50	
Aluminum alloy	Lightweight M5 threaded bar L 130 mm	
	B00020019A € 4.50	

Mini hybrid fixator kit - Spare parts

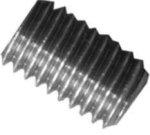
	Stainless steel	Pin-locking screw, L 8 mm
		V00020001A
		€ 0.40
	Stainless steel	Pin-locking screw, L 12 mm
		V00020002A
		€ 0.45
	Stainless steel	Pin-locking screw, L 16 mm
		V00020003A
		€ 0.50





Universal system - Midi hybrid radiolucent fixator kit







	Suggested use: dogs from 5 to 35 kg body weight	Midi hybrid radiolucent fixator kit
		K00010005A
		€ 1,241.25

COMPOSITION OF THE KIT







CODE	QTY	CODE	QTY	CODE	QTY	CODE	QTY
C00040016A	1	A00020007B	2	A00020011B	3	B00020007A	4
B00020008A	4	B00020009A	4	B00020010A	4	B00020011A	4
B00020012A	4	B00020013A	4	B00020014A	4	B00040002A	1
B00040004A	1	B00040006A	1	B00040008A	1	C00020001A	1
C00020002A	1	C00020003A	1	D00010003A	20	D00010008A	1
D00010018A	3	D00010019A	20	D00020003A	12	D00020004A	2
F00020156A	4	F00020158A	6	F00020159A	6	F00020176A	4
F00020169A	4	G00010001A	4	G00010004A	4	M00010003A	3
M00010020A	4	M00010021A	4	P00040002A	4	P00040005A	8
R00020002A	3	R00020003A	20	R00030001A	4	R00030002A	12
R00030008A	24	R00030009A	6	V00020001A	4	V00020002A	4
V00020003A	4	V00030001A	12				

Midi hybrid radiolucent fixator kit - Spare parts





	Thermoplastic material	Autoclavable box for midi hybrid radiolucent fixator kit
		C00040016A
		€ 30.00
	Carbon composite	Carbon ring 270°, Ø 84 mm, 6 mm thick
		A00020007B
		€ 55.00
	Carbon composite	Carbon ring 360°, Ø 84 mm, 6 mm thick
		A00020011B
		€ 55.00
	Aluminum alloy	Wire/pin holding clamp, M6 thread
		M00010003A
		€ 9.00

Midi hybrid radiolucent fixator kit - Spare parts		
	Technopolymer	Radiolucent 1-hole rail, orthogonal, M6 thread B00040004A € 34.00
		Radiolucent 1-hole rail, inclinable, M6 thread B00040002A € 36.00
	Technopolymer	Radiolucent 2-hole rail, orthogonal, M6 thread B00040008A € 40.00
		Radiolucent 2-hole rail, inclinable, M6 thread B00040006A € 40.00
	Aluminum alloy screw and 2 washer included	1-hole pin-holding cylinder C00020001A € 10.00
	Aluminum alloy screw and 2 washer included	2-hole pin-holding cylinder C00020002A € 14.00
	Aluminum alloy screw and 2 washer included	3-hole pin-holding cylinder C00020003A € 18.00
	Stainless steel M3 thread	Hook Ø 3 mm L 16.5 mm x 5.0 mm G00010001A € 3.00
		Hook Ø 3 mm L 16.5 mm x 7.5 mm G00010004A € 3.00







Midi hybrid radiolucent fixator kit - Spare parts

	Technopolymer	Radiolucent round clamp Ø 20 mm, three 3 mm holes - linear layout, black
		M00010020A
		€ 10.00
	Technopolymer	Radiolucent round clamp Ø 20 mm, three 3 mm holes - triangular layout, black
		M00010021A
		€ 10.00
	Stainless steel	Hexagonal head perforated screw M5 x 21.5 mm, for K wires
		V00030001A
		€ 5.00
	Stainless steel	M6 nut for clamp and post
		D00010018A
		€ 0.50
	Stainless steel	M5 flanged nut
		D00010003A
		€ 0.40
	Aluminum alloy	M5 hemispherical nut, grey
		D00020003A
		€ 8.00
	Aluminum alloy	M6 hemispherical nut, gold
		D00020004A
		€ 8.00
	Stainless steel	Hemispherical washer 8 x 14 mm
		R00030002A
		€ 3.00
	Stainless steel	Hemispherical washer 10 x 16 mm
		R00030001A
		€ 3.00

Midi hybrid radiolucent fixator kit - Spare parts

	Stainless steel	Self-locking M3 nut
		D00010019A
		€ 0.30
	Aluminum alloy	Self-locking golden color M6 nut
D00010008A		
€ 1.35		
	Stainless steel	Self-centering rectangular washer 5.5 x 15 mm
		R00030008A
		€ 2.00
	Stainless steel	Self-centering rectangular washer 8.5 x 15 mm
		R00030009A
		€ 2.00
	Stainless steel	Round washer 7.5 x 14 mm
		R00020002A
		€ 0.20
	Stainless steel	Round washer 5.5 x 15 mm
		R00020003A
		€ 0.20
	Half tip	K wire half tip, Ø 1.2 mm L 250 mm
		F00020158A
		€ 4.10
	Half tip	K wire half tip, Ø 1.5 mm L 250 mm
		F00020159A
		€ 4.20

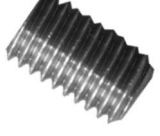
Midi hybrid radiolucent fixator kit - Spare parts

	Self-tapping 15 mm thread	Threaded pin Ø 2.4 mm L 100 mm
		F00020156A
		€ 10.50
	Self-tapping 20 mm thread	Threaded pin Ø 2.8 mm L 120 mm
		F00020169A
		€ 10.50
	Self-tapping 25 mm thread	Threaded pin Ø 3.5 mm L 130 mm
		F00020176A
		€ 10.50
	Rubber	Cap for pins Ø 2.0-2.7 mm
		P00040005A
		€ 0.15
	Rubber	Cap for pins Ø 3.5 mm
		P00040002A
		€ 0.15
	Stainless steel	Pin-locking screw, L 8 mm
		V00020001A
		€ 0.40
	Stainless steel	Pin-locking screw, L 12 mm
		V00020002A
		€ 0.45
	Stainless steel	Pin-locking screw, L 16 mm
		V00020003A
		€ 0.50

Midi hybrid radiolucent fixator kit - Spare parts

	Stainless steel	M5 threaded bar L 50 mm
		B00020007A
		€ 3.00
	Stainless steel	M5 threaded bar L 70 mm
		B00020008A
		€ 3.20
	Stainless steel	M5 threaded bar L 90 mm
		B00020009A
		€ 3.60
Stainless steel	M5 threaded bar L 110 mm	
	B00020010A	
	€ 4.00	
Stainless steel	M5 threaded bar L 130 mm	
	B00020011A	
	€ 4.20	
Stainless steel	M5 threaded bar L 150 mm	
	B00020012A	
	€ 4.40	
Stainless steel	M5 threaded bar L 170 mm	
	B00020013A	
	€ 4.80	
Stainless steel	M5 threaded bar L 190 mm	
	B00020014A	
	€ 5.00	





Universal system - Midi hybrid aluminum fixator kit

	Suggested use: dogs from 5 to 35 kg body weight	Midi hybrid aluminum fixator kit
		K00010006A
		€ 1098,45







COMPOSITION OF THE KIT

CODE	QTY	CODE	QTY	CODE	QTY	CODE	QTY
C00040013A	1	B00030003A	1	F00020156A	4	R00020002A	3
A00010005A	2	B00030004A	1	F00020158A	6	R00020003A	20
A00010008A	3	B00030005A	1	F00020159A	6	R00030001A	4
B00020007A	4	C00020001A	1	F00020176A	4	R00030002A	12
B00020008A	4	C00020002A	1	F00020169A	4	R00030008A	24
B00020009A	4	C00020003A	1	G00010001A	4	R00030009A	6
B00020010A	4	D00010003A	20	G00010004A	4	V00020001A	4
B00020011A	4	D00010008A	1	M00010003A	3	V00020002A	4
B00020012A	4	D00010018A	3	M00010020A	4	V00020003A	4
B00020013A	4	D00010019A	20	M00010021A	4	V00030001A	12
B00020014A	4	D00020003A	12	P00040002A	4		
B00030001A	1	D00020006A	2	P00040005A	8		







Midi hybrid aluminum fixator kit - Spare parts

	Thermoplastic material	Autoclavable box for midi hybrid aluminum fixator kit
		C00040013A
		€ 30.00
	Aluminum alloy	Ring 270°, Ø 85 mm, 6 mm thick, gold
		A00010005A
		€ 28.00
	Aluminum alloy	Ring 360°, Ø 85 mm, 6 mm thick, gold
		A00010008A
		€ 30.00
	Aluminum alloy	Wire/pin holding clamp, M6 thread
		M00010003A
		€ 9.00





Midi hybrid aluminum fixator kit - Spare parts

	Aluminum alloy	1-hole rail, orthogonal, M8 thread	B00030003A	€ 30.60
	Aluminum alloy	1-hole rail, inclinable, M7 thread	B00030001A	€ 32.40
	Aluminum alloy	2-hole rail, orthogonal, M8 thread	B00030005A	€ 36.60
	Aluminum alloy	2-hole rail, inclinable, M7 thread	B00030004A	€ 36.60
	Aluminum alloy screw and 2 washer included	1-hole pin-holding cylinder	C00020001A	€ 10.00
	Aluminum alloy screw and 2 washer included	2-hole pin-holding cylinder	C00020002A	€ 14.00
	Aluminum alloy screw and 2 washer included	3-hole pin-holding cylinder	C00020003A	€ 18.00
	Stainless steel M3 thread	Hook Ø 3 mm L 16.5 mm x 5.0 mm	G00010001A	€ 3.00
	Stainless steel M3 thread	Hook Ø 3 mm L 16.5 mm x 7.5 mm	G00010004A	€ 3.00







Midi hybrid aluminum fixator kit - Spare parts

	Thermoplastic material	Radiolucent round clamp Ø 20 mm, three 3 mm holes - linear layout, black
		M00010020A
		€ 10.00
	Thermoplastic material	Radiolucent round clamp Ø 20 mm, three 3 mm holes - triangular layout, black
		M00010021A
		€ 10.00
	Stainless steel	Hexagonal head perforated screw M5 x 21.5 mm, for K wires
		V00030001A
		€ 5.00
	Stainless steel	M6 nut for clamp and post
		D00010018A
		€ 0.50
	Stainless steel	M5 flanged nut
		D00010003A
		€ 0.40
	Aluminum alloy	M5 hemispherical nut
		D00020003A
	Aluminum alloy	M7 hemispherical nut
		D00020006A
	Stainless steel	Hemispherical washer 8 x 14 mm
		R00030002A
Stainless steel	Hemispherical washer 10 x 16 mm	
	R00030001A	

Midi hybrid aluminum fixator kit - Spare parts

	Stainless steel	Self-locking M3 nut
		D00010019A
	€ 0.30	
	Aluminum alloy	Self-locking golden color M6 nut
D00010008A		
€ 1.35		
	Stainless steel	Self-centering rectangular washer 5.5 x 15 mm
		R00030008A
	€ 2.00	
	Stainless steel	Self-centering rectangular washer 8.5 x 15 mm
R00030009A		
€ 2.00		
	Stainless steel	Round washer 7.5 x 14 mm
		R00020002A
	€ 0.20	
	Stainless steel	Round washer 5.5 x 15 mm
R00020003A		
€ 0.20		
	Half tip	K wire half tip, Ø 1.2 mm L 250 mm
		F00020158A
	€ 4.10	
	Half tip	K wire half tip, Ø 1.5 mm L 250 mm
F00020159A		
€ 4.20		

Midi hybrid aluminum fixator kit - Spare parts

	Self-tapping 15 mm thread	Threaded pin Ø 2.4 mm L 100 mm
		F00020156A
		€ 10.50
	Self-tapping 20 mm thread	Threaded pin Ø 2.8 mm L 130 mm
		F00020169A
		€ 10.50
	Self-tapping 25 mm thread	Threaded pin Ø 3.5 mm L 130 mm
		F00020176A
		€ 10.50
	Rubber	Cap for pins Ø 2.0-2.7 mm
		P00040005A
		€ 0.15
	Rubber	Cap for pins Ø 3.5 mm
		P00040002A
		€ 0.15
	Stainless steel	Pin-locking screw, L 8 mm
		V00020001A
		€ 0.40
	Stainless steel	Pin-locking screw, L 12 mm
		V00020002A
		€ 0.45
Stainless steel	Pin-locking screw, L 16 mm	
	V00020003A	
	€ 0.50	

Midi hybrid aluminum fixator kit - Spare parts

	Stainless steel	M5 threaded bar L 50 mm
		B00020007A
		€ 3.00
	Stainless steel	M5 threaded bar L 70 mm
		B00020008A
		€ 3.20
	Stainless steel	M5 threaded bar L 90 mm
		B00020009A
		€ 3.60
Stainless steel	M5 threaded bar L 110 mm	
	B00020010A	
	€ 4.00	
Stainless steel	M5 threaded bar L 130 mm	
	B00020011A	
	€ 4.20	
Stainless steel	M5 threaded bar L 150 mm	
	B00020012A	
	€ 4.40	
Stainless steel	M5 threaded bar L 170 mm	
	B00020013A	
	€ 4.80	
Stainless steel	M5 threaded bar L 190 mm	
	B00020014A	
	€ 5.00	





Universal system - Maxi hybrid fixator kit









	<p>Suggested use: dogs over 25 kg body weight</p>	Maxi hybrid fixator kit
		K00010007A
		€ 1,191.90

COMPOSITION OF THE KIT

CODE	QTY	CODE	QTY	CODE	QTY	CODE	QTY
C00040015A	1	B00030003A	1	D00020006A	2	P00040003A	4
A00010006A	2	B00030004A	1	F00020158A	6	P00040005A	8
A00010009A	3	B00030005A	1	F00020159A	6	R00020002A	3
B00020007A	4	B00030006A	1	F00020176A	4	R00020003A	20
B00020008A	4	B00030007A	1	F00020177A	4	R00030001A	4
B00020009A	4	C00020001A	1	F00020169A	4	R00030002A	12
B00020010A	4	C00020002A	1	G00010001A	4	R00030008A	24
B00020011A	4	C00020003A	1	G00010004A	4	R00030009A	6
B00020012A	4	D00010003A	20	M00010003A	3	V00020001A	4
B00020013A	4	D00010018A	3	M00010020A	4	V00020002A	4
B00020014A	4	D00010019A	20	M00010021A	4	V00020003A	4
B00030001A	1	D00020003A	12	P00040002A	4	V00030001A	12









Maxi hybrid fixator kit - Spare parts

	<p>Thermoplastic material</p>	Autoclavable box for maxi hybrid fixator kit
		C00040015A
		€ 30.00
	<p>Aluminum alloy</p>	Ring 270°, Ø 115 mm, 6 mm thick, blue
		A00010006A
		€ 31.00
	<p>Aluminum alloy</p>	Ring 360°, Ø 115 mm, 6 mm thick, blue
		A00010009A
		€ 33.00
	<p>Aluminum alloy</p>	Wire/pin holding clamp, M6 thread
		M00010003A
		€ 9.00

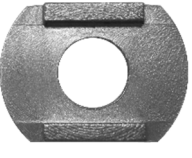





Maxi hybrid fixator kit - Spare parts		
	Aluminum alloy	1-hole rail, orthogonal, M8 thread
		B00030003A
		€ 30.60
	Aluminum alloy	1-hole rail, inclinable, M7 thread
		B00030001A
		€ 32.40
	Aluminum alloy	2-hole rail, orthogonal, M8 thread
		B00030005A
		€ 36.60
	Aluminum alloy	2-hole rail, inclinable, M7 thread
		B00030004A
		€ 36.60
	Aluminum alloy	3-hole rail, orthogonal, M8 thread
		B00030007A
		€ 39.60
	Aluminum alloy	3-hole rail, inclinable, M7 thread
		B00030006A
		€ 39.60
	Aluminum alloy, screw and 2 washer included	1-hole pin-holding cylinder
		C00020001A
		€ 10.00
	Aluminum alloy, screw and 2 washer included	2-hole pin-holding cylinder
		C00020002A
		€ 14.00
	Aluminum alloy, screw and 2 washer included	3-hole pin-holding cylinder
		C00020003A
		€ 18.00

Maxi hybrid fixator kit - Spare parts

	Stainless steel M3 thread	Hook Ø 3 mm L 16.5 mm x 5.0 mm
		G00010001A
		€ 3.00
	Stainless steel M3 thread	Hook Ø 3 mm L 16.5 mm x 7.5 mm
		G00010004A
		€ 3.00
	Technopolymer	Radiolucent round clamp Ø 20 mm, three 3 mm holes - linear layout, black
		M00010020A
		€ 10.00
	Technopolymer	Radiolucent round clamp Ø 20 mm, three 3 mm holes - triangular layout, black
		M00010021A
		€ 10.00
	Stainless steel	Hexagonal head perforated screw M5 x 21.5 mm, for K wires
		V00030001A
		€ 5.00
	Stainless steel	M6 nut for clamp and post
		D00010018A
		€ 0.50
	Stainless steel	M5 flanged nut
		D00010003A
		€ 0.40
	Aluminum alloy	M5 hemispherical nut, grey
		D00020003A
	Aluminum alloy	M7 hemispherical nut, red
D00020006A		
		€ 8.00

Maxi hybrid fixator kit - Spare parts		
	Stainless steel	Hemispherical washer 8 x 14 mm
		R00030002A
		€ 3.00
	Stainless steel	Hemispherical washer 10 x 16 mm
		R00030001A
		€ 3.00
	Stainless steel	Self-locking M3 nut
		D00010019A
		€ 0.30
	Stainless steel	Self-centering rectangular washer 5.5 x 15 mm
		R00030008A
		€ 2.00
	Stainless steel	Self-centering rectangular washer 8.5 x 15 mm
		R00030009A
		€ 2.00
	Stainless steel	Round washer 7.5 x 14 mm
		R00020002A
		€ 0.20
	Stainless steel	Round washer 5.5 x 15 mm
		R00020003A
		€ 0.20
	Half tip	K wire half tip, Ø 1.2 mm L 250 mm
		F00020158A
		€ 4.10
	Half tip	K wire half tip, Ø 1.5 mm L 250 mm
		F00020159A
		€ 4.20

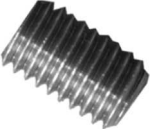
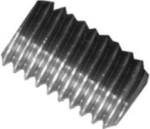
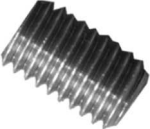

Maxi hybrid fixator kit - Spare parts

	Self-tapping 20 mm thread	Threaded pin Ø 2.8 mm L 120 mm
		F00020169A
		€ 10.50
	Self-tapping 25 mm thread	Threaded pin Ø 3.5 mm L 130 mm
		F00020176A
		€ 10.50
	Self-tapping 25 mm thread	Threaded pin Ø 4.5 mm L 130 mm
		F00020177A
		€ 10.50
	Rubber	Cap for pins Ø 2.0-2.7 mm
		P00040005A
		€ 0.15
	Rubber	Cap for pins Ø 3.5 mm
		P00040002A
		€ 0.15
	Rubber	Cap for pins Ø 4.5 mm
		P00040003A
		€ 0.15
	Stainless steel	Pin-locking screw, L 8 mm
		V00020001A
		€ 0.40
	Stainless steel	Pin-locking screw, L 12 mm
		V00020002A
		€ 0.45
	Stainless steel	Pin-locking screw, L 16 mm
		V00020003A
		€ 0.50





Maxi hybrid fixator kit - Spare parts

	Stainless steel	M5 threaded bar L 50 mm
		B00020007A
		€ 3.00
	Stainless steel	M5 threaded bar L 70 mm
		B00020008A
		€ 3.20
	Stainless steel	M5 threaded bar L 90 mm
		B00020009A
€ 3.60		
Stainless steel	M5 threaded bar L 110 mm	
	B00020010A	
	€ 4.00	
Stainless steel	M5 threaded bar L 130 mm	
	B00020011A	
	€ 4.20	
Stainless steel	M5 threaded bar L 150 mm	
	B00020012A	
	€ 4.40	
Stainless steel	M5 threaded bar L 170 mm	
	B00020013A	
	€ 4.80	
Stainless steel	M5 threaded bar L 190 mm	
	B00020014A	
	€ 5.00	





Universal system - Hybrid fixation overall elements









	Aluminum alloy	Ring 360° Ø 115 mm, 6 mm thick, blue
		A00010009A
		€ 33.00
	Aluminum alloy	Ring 360° Ø 85 mm, 6 mm thick, gold
		A00010008A
		€ 30.00
Carbon composite	Ring 360° Ø 84 mm, 6 mm thick	
	A00020011B	
	€ 55.00	
	Aluminum alloy	Ring 360° Ø 55 mm, 6 mm thick, red
		A00010007A
		€ 25.00
	Carbon composite	Ring 360° Ø 54 mm, 6 mm thick
		A00020010B
		€ 42.00
Carbon composite	Ring 360° Ø 54 mm, 3 mm thick	
	A00020009B	
	€ 40.00	
	Aluminum alloy	Ring 270° Ø 115 mm, 6 mm thick, blue
		A00010006A
		€ 31.00
	Aluminum alloy	Ring 270° Ø 85 mm, 6 mm thick, gold
		A00010005A
		€ 28.00
Carbon composite	Ring 270° Ø 84 mm, 6 mm thick	
	A00020007B	
	€ 55.00	

Universal system - Hybrid fixation overall elements





	Aluminum alloy	Ring 270° Ø 55 mm, 6 mm thick, red
		A00010004A
		€ 25.00
	Carbon composite	Ring 270° Ø 54 mm, 6 mm thick
		A00020006B
		€ 38.00
Carbon composite	Ring 270° Ø 54 mm, 3 mm thick	
	A00020005B	
	€ 37.00	
	Aluminum alloy	Ring 180° Ø 115 mm, 6 mm thick, blu
		A00010003A
		€ 23.00
	Aluminum alloy	Ring 180° Ø 85 mm, 6 mm thick, gold
		A00010002A
		€ 20.00
Carbon composite	Ring 180° Ø 85 mm, 6 mm thick	
	A00020003A	
	€ 29.00	
	Aluminum alloy	Ring 180° Ø 55 mm, 6 mm thick, red
		A00010001A
		€ 17.00
	Carbon composite	Ring 180° Ø 55 mm, 6 mm thick
A00020002A		
	Stainless steel, M7 thread	Coupling with right/left-handed thread
		R00010001A
		€ 34.00



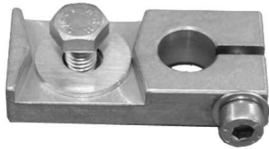

Universal system - Hybrid fixation overall elements

	Aluminum alloy	1-hole rail, orthogonal, M8 thread	B00030003A	€ 30.60
	Aluminum alloy	1-hole rail, inclinable, M7 thread	B00030001A	€ 32.40
	Aluminum alloy	1-hole rail, M7 left-handed thread	B00030002A	€ 34.00
	Technopolymer	Radiolucent 1-hole rail, orthogonal, M6 thread	B00040004A	€ 34.00
	Technopolymer	Radiolucent 1-hole rail, inclinable, M6 thread	B00040002A	€ 36.00
 	Aluminum alloy	2-hole rail, orthogonal, M8 thread	B00030005A	€ 36.60
	Aluminum alloy	2-hole rail, inclinable, M7 thread	B00030004A	€ 36.60
	Technopolymer	Radiolucent 2-hole rail, orthogonal, M6 thread	B00040008A	€ 40.00
	Technopolymer	Radiolucent 2-hole rail, inclinable, M6 thread	B00040006A	€ 40.00





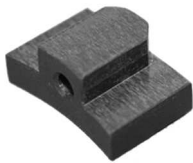

Universal system - Hybrid fixation overall elements		
	Aluminum alloy	3-hole rail, orthogonal, M8 thread
		B00030007A
		€ 39.60
	Aluminum alloy	3-hole rail, inclinable, M7 thread
		B00030006A
		€ 39.60
	Technopolymer	Radiolucent 3-hole rail, orthogonal, M6 thread
		B00040010A
		€ 44.00
	Technopolymer	Radiolucent 3-hole rail, inclinable, M6 thread
		B00040009A
		€ 44.00
	Aluminum alloy	Double-purchase post, M6 thread
		M00010001A
		€ 18.00
	Aluminum alloy, screw and 2 washer included	1-hole pin-holding cylinder
		C00020001A
		€ 10.00
	Aluminum alloy, screw and 2 washer included	2-hole pin-holding cylinder
		C00020002A
		€ 14.00
	Aluminum alloy, screw and 2 washer included	3-hole pin-holding cylinder
		C00020003A
		€ 18.00
	Aluminum alloy	80 mm inclinable cylindrical rod, M7 thread
		A00030001A
		€ 24.00

Universal system - Hybrid fixation overall elements

	Aluminum alloy	110 mm inclinable cylindrical rod, M7 thread
		A00030002A
		€ 28.00
	Stainless steel	Cardan joint, M5 connection
		G00020001A
		€ 90.00
	Stainless steel	Transarticular round joint, M8 connection
		G00020002A
		€ 32.00
	Stainless steel	Linear/circular connector
		M00010002A
		€ 16.00
	Stainless steel	M6 nut for clamp and post
		D00010018A
		€ 0.50
	Aluminum alloy	M4 hemispherical nut, blue
		D00020001A
		€ 8.00
	Aluminum alloy	M5 hemispherical nut, grey
		D00020003A
		€ 8.00
	Aluminum alloy	M6 hemispherical nut, gold
		D00020004A
		€ 8.00
	Aluminum alloy	M7 hemispherical nut, red
		D00020006A
		€ 8.00

Universal system - Hybrid fixation overall elements		
	Stainless steel	M5 flanged nut
		D00010003A
		€ 0.40
	Stainless steel	M5 nut for stabilization hook
		D00020008A
		€ 2.70
	Stainless steel	Hexagonal head perforated screw M5 x 13.5 mm, for K wires
		V00030002A
		€ 2.50
	Stainless steel	Hexagonal head perforated screw M5 x 21.5 mm, for K wires
		V00030001A
		€ 5.00
	Stainless steel	Dynamometric wire tensioner
		U00010001A
		€ 300.00
	Thermoplastic material	Spacer for dynamometric wire tensioner
		D00030001A
		€ 22.00
	Stainless steel	Round washer 7.5 x 14 mm
		R00020002A
		€ 0.20
	Stainless steel	Round washer 5.5 x 15 mm
		R00020003A
		€ 0.20



Universal system - Hybrid fixation overall elements



	Stainless steel	Rectangular washer 5.5 mm hole
		R00030005A
		€ 1.00
	Stainless steel	Rectangular washer 8.5 mm hole
		R00030006A
		€ 1.00
	Stainless steel	Self-centering rectangular washer 5.5x15 mm
		R00030008A
		€ 2.00
	Stainless steel	Self-centering rectangular washer 8.5x15 mm
		R00030009A
		€ 2.00
	Stainless steel	Hemispherical washer 8x14 mm
		R00030002A
		€ 3.00
	Stainless steel	Hemispherical washer 10x16 mm
		R00030001A
		€ 3.00
Thermoplastic material	Radiolucent hemispherical washer 8x13 mm	
	R00030004A	
	€ 4.00	
	Stainless steel	Malleable rod Ø 3 mm, 20-cm long
		B00010008A
		€ 2.00
	Aluminum alloy	Wire/pin holding clamp, M6 thread
		M00010003A
		€ 9.00

Universal system - Hybrid fixation overall elements

	Stainless steel	M5 threaded bar L 50 mm
		B00020007A
		€ 3.00
	Stainless steel	M5 threaded bar L 70 mm
		B00020008A
		€ 3.20
	Stainless steel	M5 threaded bar L 90 mm
		B00020009A
		€ 3.60
Stainless steel	M5 threaded bar L 110 mm	
	B00020010A	
	€ 4.00	
Stainless steel	M5 threaded bar L 130 mm	
	B00020011A	
	€ 4.20	
Stainless steel	M5 threaded bar L 150 mm	
	B00020012A	
	€ 4.40	
Stainless steel	M5 threaded bar L 170 mm	
	B00020013A	
	€ 4.80	
Stainless steel	M5 threaded bar L 190 mm	
	B00020014A	
	€ 5.00	

Universal system - Hybrid fixation overall elements

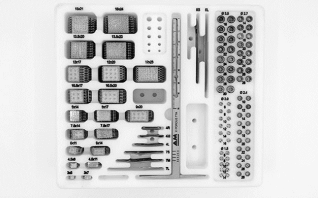
	Carbon composite	Bar Ø 5 mm L 200 mm
		B00010003A
	€ 5.00	
	Carbon composite	Bar Ø 8 mm L 150 mm
B00010004A		
€ 5.00		
Carbon composite	Bar Ø 8 mm L 200 mm	
	B00010005A	
€ 6.00		
Carbon composite	Bar Ø 8 mm L 250 mm	
	B00010006A	
€ 7.00		
	Stainless steel	Wrench for Ø 3 mm hooks
		U00010006A
€ 40.00		
	Aluminum alloy handle	Socket wrench 5.5 mm for M3 nuts
		U00010014A
€ 32.00		

X-Porous TTA – Containers		
	<p>Technopolymer</p>	<p style="background-color: #cccccc;">Autoclavable case with cover for reduced kit</p> <p style="background-color: #cccccc;">C00040006A</p> <p>€ 180.00</p>
	<p>Technopolymer</p>	<p style="background-color: #cccccc;">Autoclavable case with cover for extended implants kit</p> <p style="background-color: #cccccc;">C00040019A</p> <p>€ 300.00</p>
	<p>Thermoplastic material</p>	<p style="background-color: #cccccc;">Autoclavable case for extended implants and instruments kit</p> <p style="background-color: #cccccc;">C00040021A</p> <p>€ 200.00</p>

X-Porous TTA - Screws



	Titanium	Screw Ø 1.5 x 6 mm
		V00040076A
		€ 8.80
	Titanium	Screw Ø 1.5 x 8 mm
		V00040077A
		€ 8.80
	Titanium	Screw Ø 1.5 x 10 mm
		V00040078A
		€ 8.80
	Titanium	Screw Ø 1.5 x 12 mm
V00040079A		
€ 8.80		
Titanium	Screw Ø 1.5 x 14 mm	
	V00040080A	
	€ 8.80	
Titanium	Self-tapping screw Ø 2.0 x 6 mm	
	V00040081A	
	€ 8.80	
	Titanium	Self-tapping screw Ø 2.0 x 8 mm
V00040082A		
€ 8.80		
Titanium	Self-tapping screw Ø 2.0 x 10 mm	
	V00040083A	
	€ 8.80	
Titanium	Self-tapping screw Ø 2.0 x 12 mm	
	V00040084A	
	€ 8.80	

	Titanium	Self-tapping screw Ø 2.0 x 14 mm
		V00040085A
		€ 8.80
	Titanium	Self-tapping screw Ø 2.0 x 16 mm
		V00040086A
		€ 8.80
	Titanium	Self-tapping screw Ø 2.4 x 10 mm
		V00040043A
		€ 8.80
	Titanium	Self-tapping screw Ø 2.4 x 12 mm
		V00040039A
		€ 8.80
	Titanium	Self-tapping screw Ø 2.4 x 14 mm
		V00040044A
		€ 8.80
	Titanium	Self-tapping screw Ø 2.4 x 16 mm
		V00040059A
		€ 8.80
	Titanium	Self-tapping screw Ø 2.4 x 18 mm
		V00040060A
		€ 8.80
	Titanium	Self-tapping screw Ø 2.4 x 20 mm
		V00040061A
		€ 8.80
	Titanium	Self-tapping screw Ø 2.4 x 22 mm
		V00040062A
		€ 8.80

	Titanium	Self-tapping screw Ø 2.4 x 24 mm
		V00040063A
		€ 8.80
	Titanium	Self-tapping screw Ø 2.4 x 26 mm
		V00040064A
		€ 8.80
	Titanium	Self-tapping screw Ø 2.4 x 28 mm
		V00040065A
		€ 8.80
	Titanium	Self-tapping screw Ø 2.7 x 14 mm
		V00040066A
		€ 8.80
	Titanium	Self-tapping screw Ø 2.7 x 16 mm
		V00040067A
		€ 8.80
	Titanium	Self-tapping screw Ø 2.7 x 18 mm
		V00040068A
		€ 8.80
	Titanium	Self-tapping screw Ø 2.7 x 20 mm
		V00040045A
		€ 8.80
	Titanium	Self-tapping screw Ø 2.7 x 22 mm
		V00040069A
		€ 8.80
	Titanium	Self-tapping screw Ø 2.7 x 24 mm
		V00040046A
		€ 8.80
	Titanium	Self-tapping screw Ø 2.7 x 26 mm
		V00040047A
		€ 8.80











Titanium	Self-tapping screw Ø 3.5 x 16 mm
	V00040048A
	€ 8.80
Titanium	Self-tapping screw Ø 3.5 x 18 mm
	V00040049A
	€ 8.80
Titanium	Self-tapping screw Ø 3.5 x 20 mm
	V00040070A
	€ 8.80
Titanium	Self-tapping screw Ø 3.5 x 22 mm
	V00040050A
	€ 8.80
Titanium	Self-tapping screw Ø 3.5 x 24 mm
	V00040071A
	€ 8.80
Titanium	Self-tapping screw Ø 3.5 x 26 mm
	V00040072A
	€ 8.80
Titanium	Self-tapping screw Ø 3.5 x 28 mm
	V00040073A
	€ 8.80
Titanium	Self-tapping screw Ø 3.5 x 30 mm
	V00040074A
	€ 8.80









X-Porous TTA - Wedges



	Titanium	Titanium wedge 15x24x33
		I00030044A
		€ 70.00
	Titanium	Titanium wedge 15x21x33
		I00030043A
		€ 70.00
	Titanium	Titanium wedge 13.5x23x33
		I00030042A
		€ 70.00
Titanium	Titanium wedge 13.5x20x33	
	I00030041A	
	€ 70.00	
Titanium	Titanium wedge 4.0 12x20x30	
	I00030059A	
	€ 70.00	
Titanium	Titanium wedge 4.0 12x17x30	
	I00030058A	
	€ 70.00	
Titanium	Titanium wedge 4.0 10.5x20x28	
	I00030057A	
	€ 70.00	
Titanium	Titanium wedge 4.0 10.5x17x28	
	I00030056A	
	€ 70.00	
Titanium	Titanium wedge 4.0 9x20x26	
	I00030055A	
	€ 70.00	

X-Porous TTA - Wedges		
	Titanium	Titanium wedge 4.0 9x17x26
		I00030054A
		€ 70.00
	Titanium	Titanium wedge 4.0 9x14x26
		I00030053A
		€ 70.00
	Titanium	Titanium wedge 4.0 7.5x17x22
		I00030052A
		€ 70.00
	Titanium	Titanium wedge 4.0 7.5x14x22
I00030051 A		
€ 70.00		
Titanium	Titanium wedge 4.0 6x14x20	
	I00030050A	
	€ 70.00	
Titanium	Titanium wedge 4.0 6x11x20	
	I00030049A	
	€ 70.00	
Titanium	Titanium wedge 4.0 4.5x11x13	
	I00030048A	
	€ 70.00	
Titanium	Titanium wedge 4.0 4.5x8x13	
	I00030047 A	
	€ 70.00	
Titanium	Titanium wedge 4.0 3x7x8	
	I00030046A	
	€ 70.00	
Titanium	Titanium wedge 4.0 3x5x8	
	I00030045A	
	€ 70.00	

X-Porous TTA - Plates		
	Titanium	Plate 8L 3.0
		I00020048A
		€ 23.00
	Titanium	Plate 8S 3.0
		I00020049A
		€ 23.00
	Titanium	Plate 7L 3.0
		I00020045A
		€ 23.00
	Titanium	Plate 7M 3.0
		I00020046A
		€ 23.00
	Titanium	Plate 7S
		I00020015A
		€ 20.00
	Titanium	Plate 4L
		I00020010A
		€ 20.00
	Titanium	Plate 4M
		I00020011A
		€ 20.00
	Titanium	Plate 4R
		I00020012A
		€ 20.00

X-Porous TTA - Tools	
	Impactor for X-Porous TTA
	S00040007A
	€ 26.00
	General distractor
	S00040006A
	€ 920.00
	Guide for osteotomy
	S00050002A
	€ 72.00
	Standard X-Porous TTA distractor
	S00040007A
	€ 180.00
	Power X-Porous TTA distractor
	S00040008A
	€ 250.00
	Drill sleeve
	C00010008A
	€ 52.00
	Screwdriver for locking screw
	U00010033A
	€ 55.00
	Fiber screwdriver for 1,5 mm hexagonal screws
	U00010028A
	€ 82.00
	Fiber screwdriver for 2,5 mm hexagonal screws
	U00010029A
	€ 82.00

	Four-Flamed screwdriver
	U00010032A
	€ 182.00



WWW.AD-MAIORA.EU



AD MAIORA SRL - CAVRIAGO (RE) - ITALY

PHONE +39 348 86 83 311

info@ad-maiora.eu